

Carême, M.A. *Le Pâtissier royal parisien, ou Traité élémentaire et pratique de la pâtisserie ancienne et moderne.* (Paris, 1815) 07 GW-119, 07 GW-120. From: **Rare Book and Manuscript CRAI Library at University of Barcelona.**

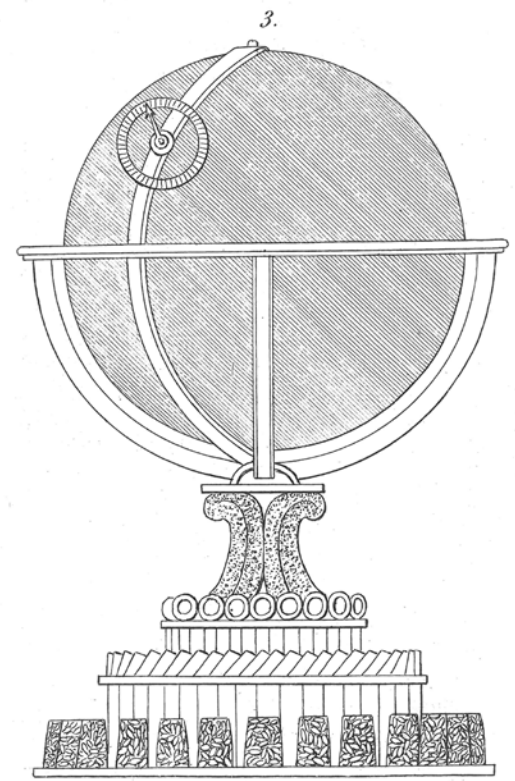

Carême, M.A. *Le Pâtissier royal parisien, ou Traité élémentaire et pratique de la pâtisserie ancienne et moderne.* (Paris, 1815) 07 GW-119, 07 GW-120. From: **Rare Book and Manuscript CRAI Library at University of Barcelona.**

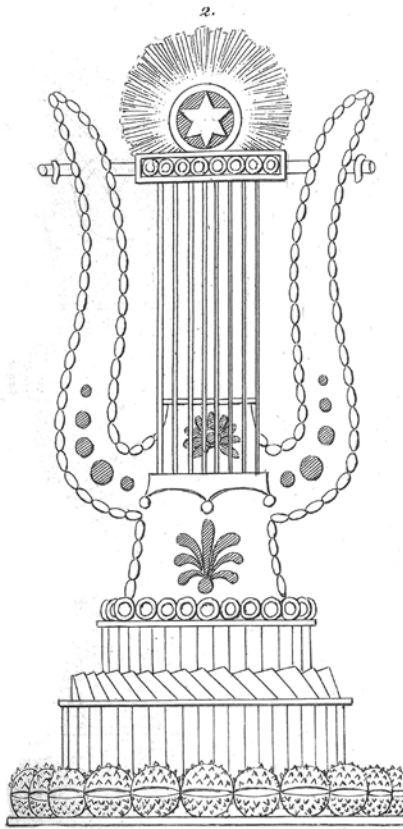
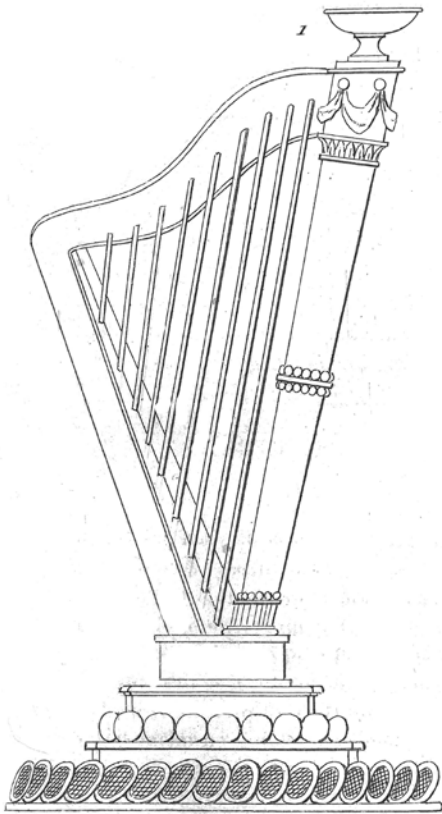
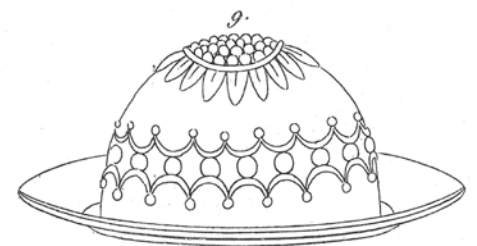
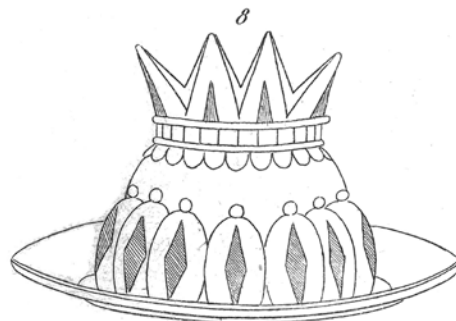
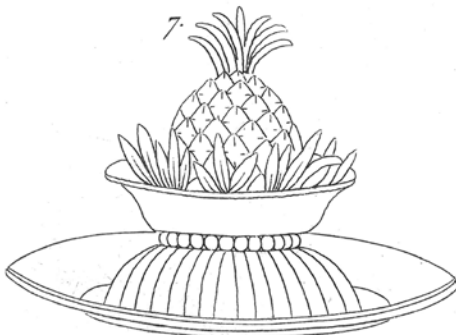
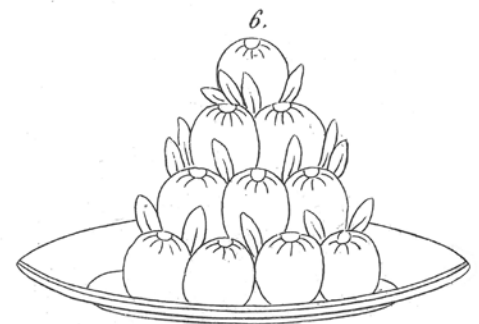
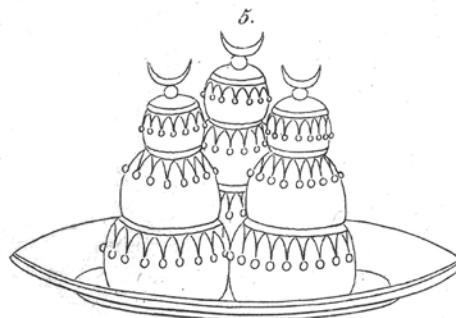
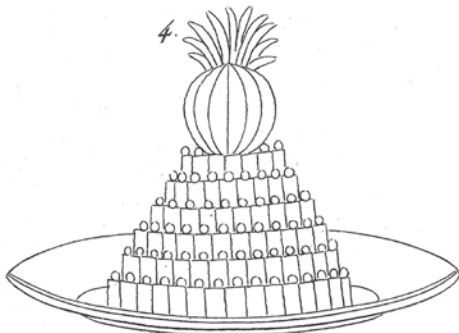
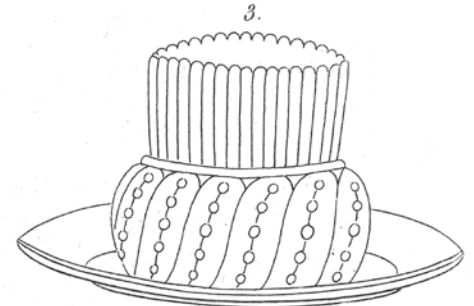
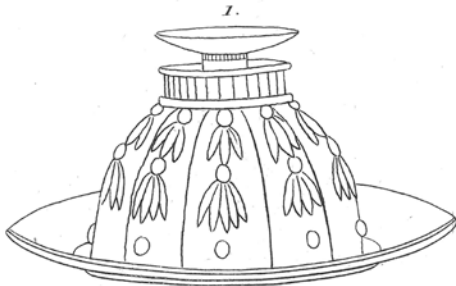

Carême, M.A. *Le Pâtissier royal parisien, ou Traité élémentaire et pratique de la pâtisserie ancienne et moderne.* (Paris, 1815) 07 GW-119, 07 GW-120. From: **Rare Book and Manuscript CRAI Library at University of Barcelona.**

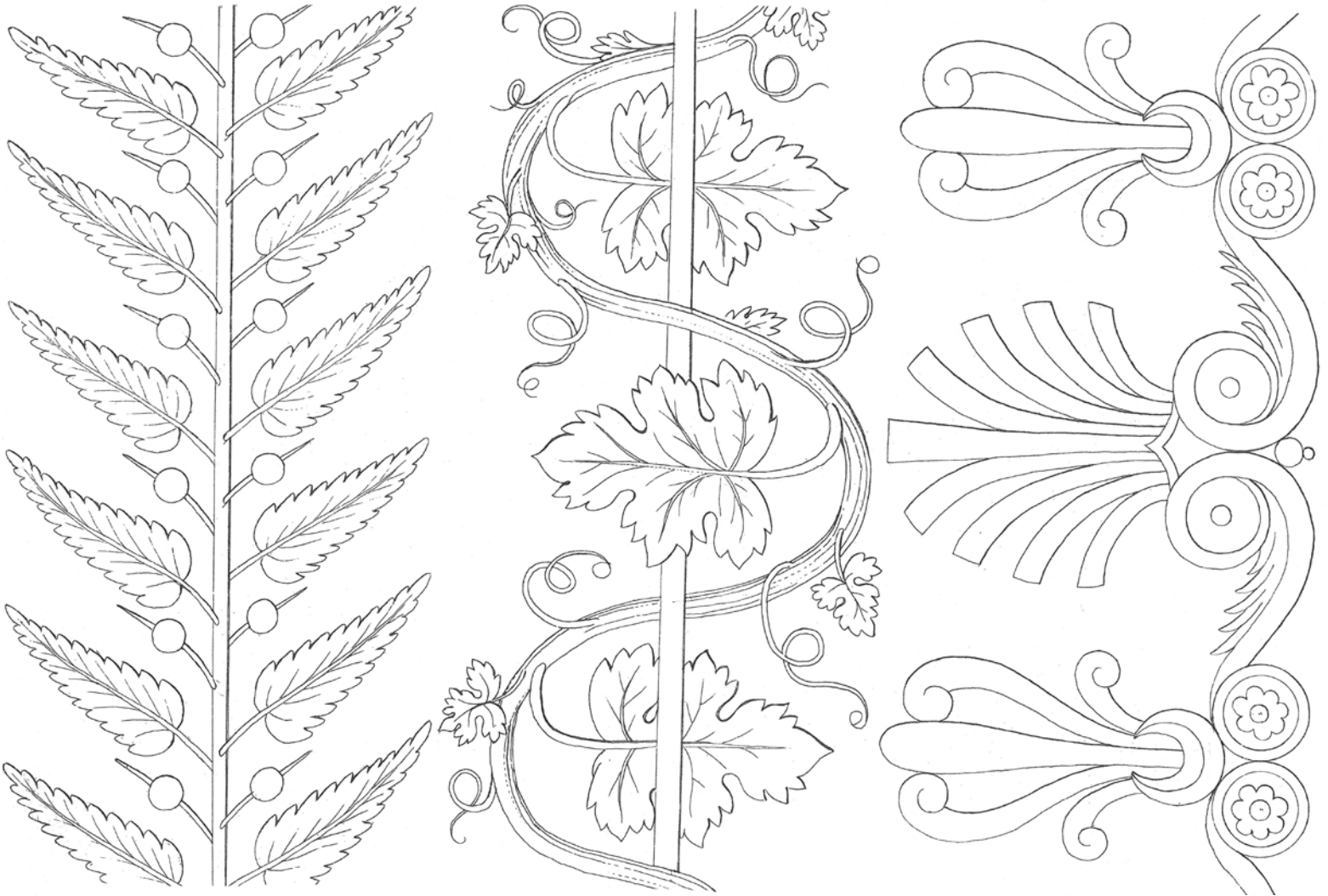

Carême, M.A. *Le Pâtissier royal parisien, ou Traité élémentaire et pratique de la pâtisserie ancienne et moderne.* (Paris, 1815) 07 GW-119, 07 GW-120. From: **Rare Book and Manuscript CRAI Library at University of Barcelona.**

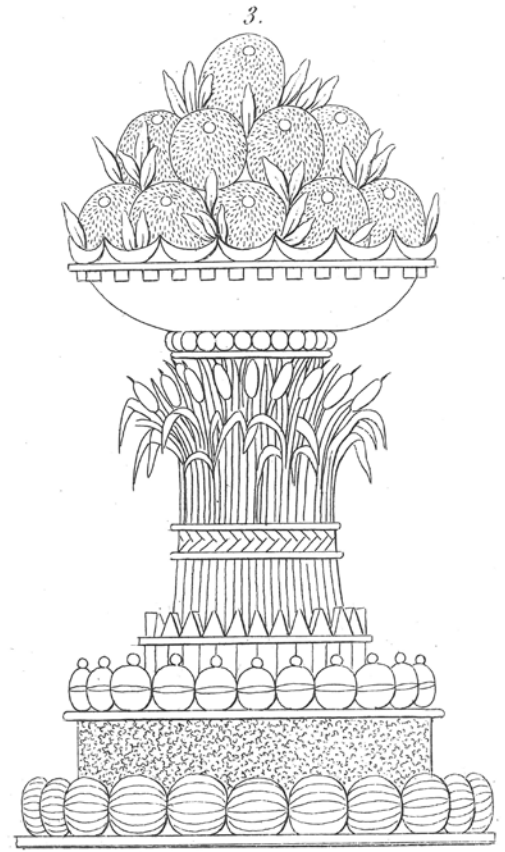
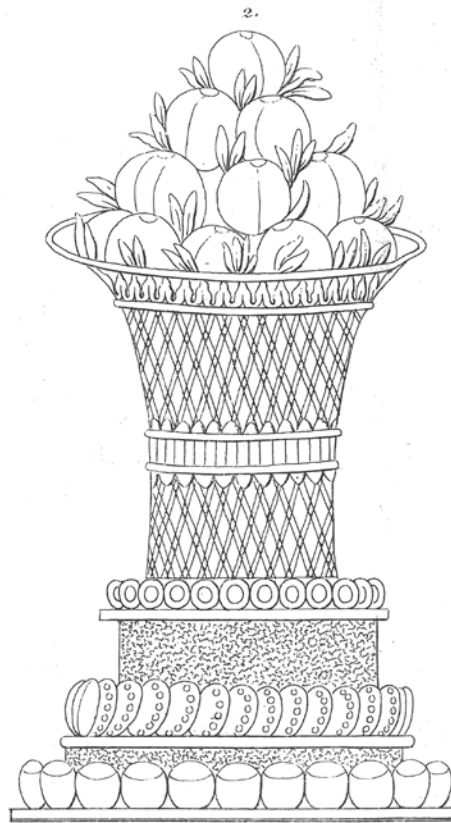
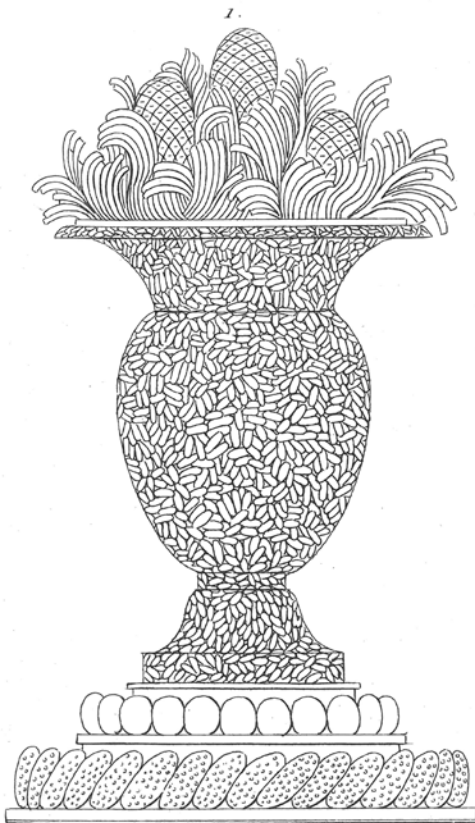

Carême, M.A. *Le Pâtissier royal parisien, ou Traité élémentaire et pratique de la pâtisserie ancienne et moderne.* (Paris, 1815) 07 GW-119, 07 GW-120. From: **Rare Book and Manuscript CRAI Library at University of Barcelona.**

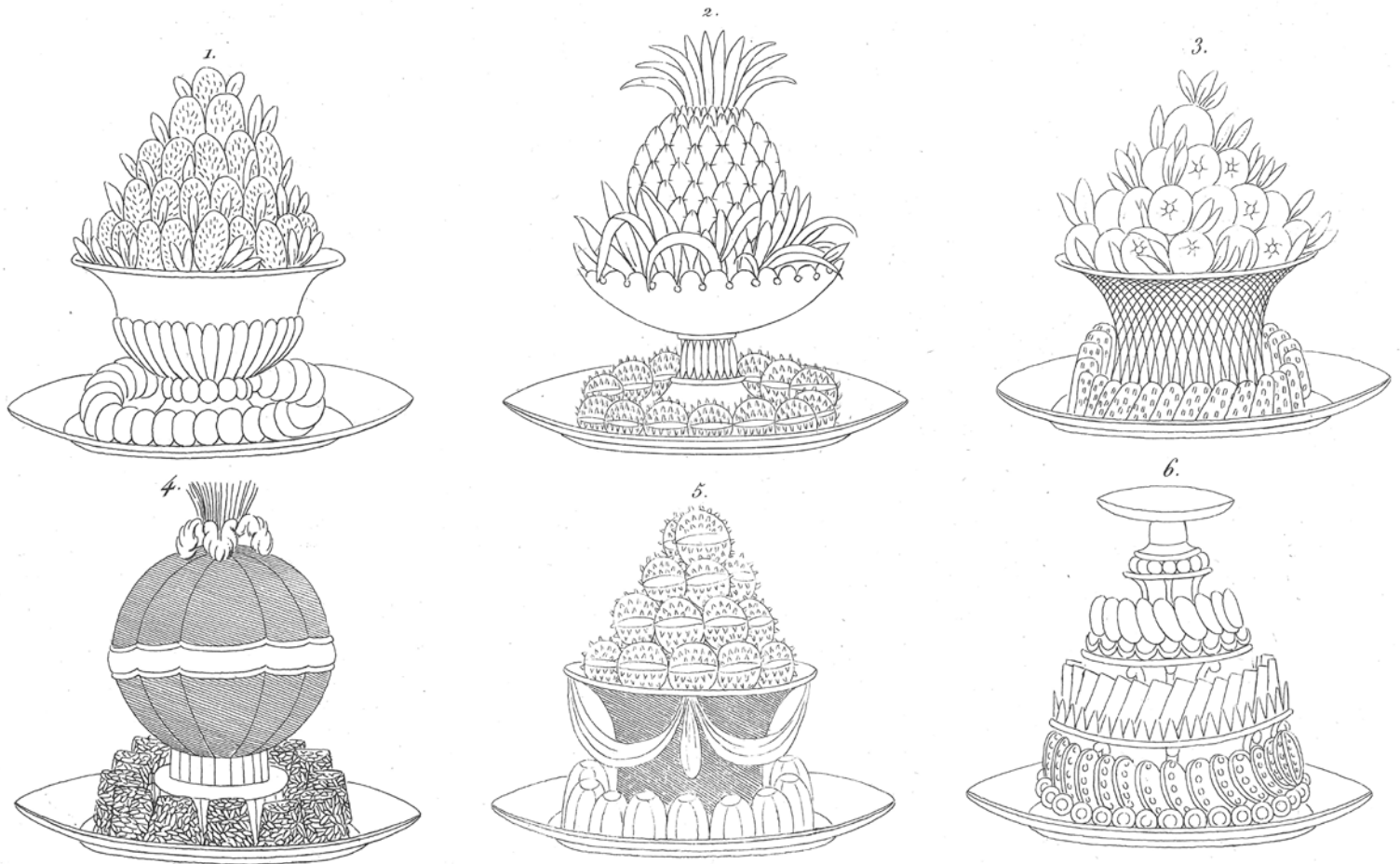

Carême, M.A. *Le Pâtissier royal parisien, ou Traité élémentaire et pratique de la pâtisserie ancienne et moderne.* (Paris, 1815) 07 GW-119, 07 GW-120. From: **Rare Book and Manuscript CRAI Library at University of Barcelona.**

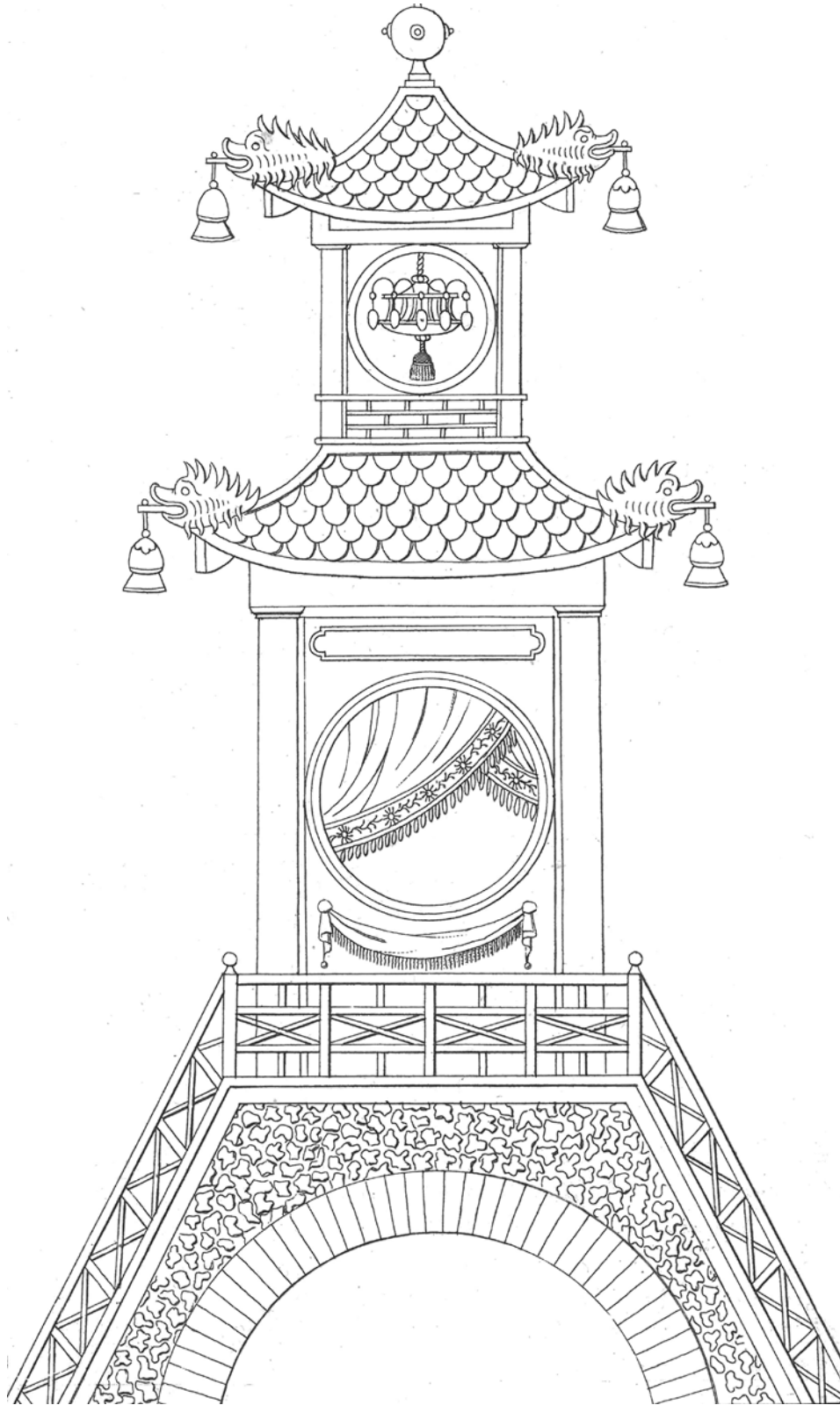

Carême, M.A. *Le Pâtissier royal parisien, ou Traité élémentaire et pratique de la pâtisserie ancienne et moderne.* (Paris, 1815) 07 GW-119, 07 GW-120. From: **Rare Book and Manuscript CRAI Library at University of Barcelona.**

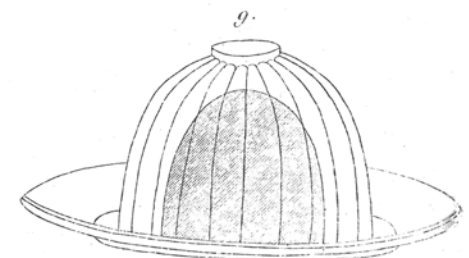
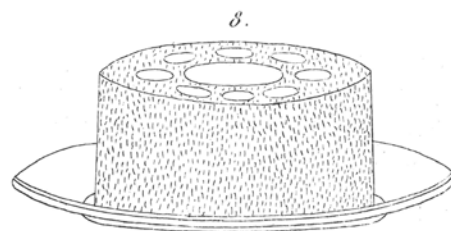
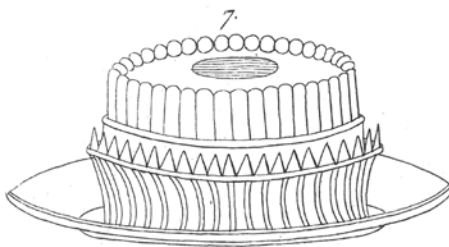
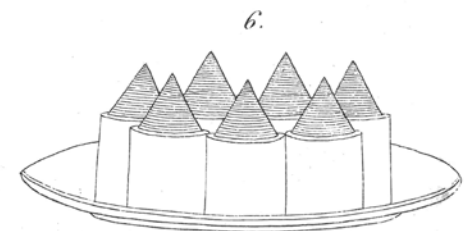
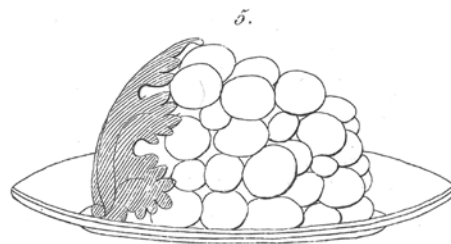
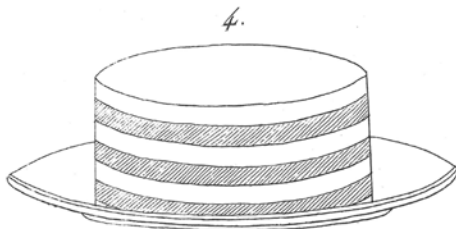
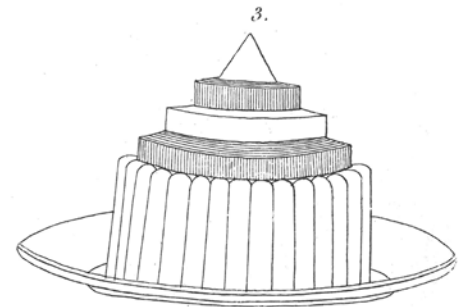
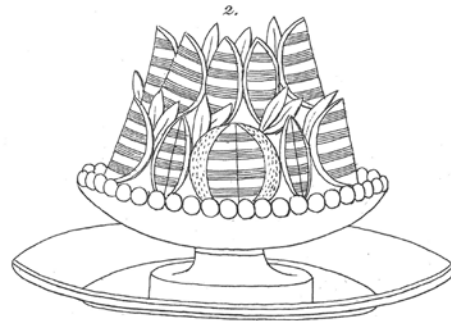
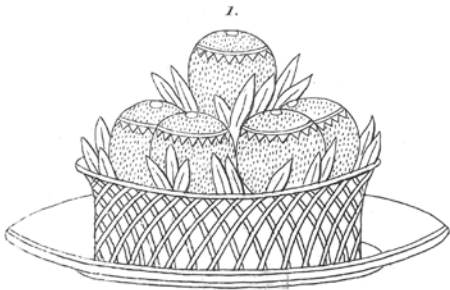

Carême, M.A. *Le Pâtissier royal parisien, ou Traité élémentaire et pratique de la pâtisserie ancienne et moderne.* (Paris, 1815) 07 GW-119, 07 GW-120. From: **Rare Book and Manuscript CRAI Library at University of Barcelona.**

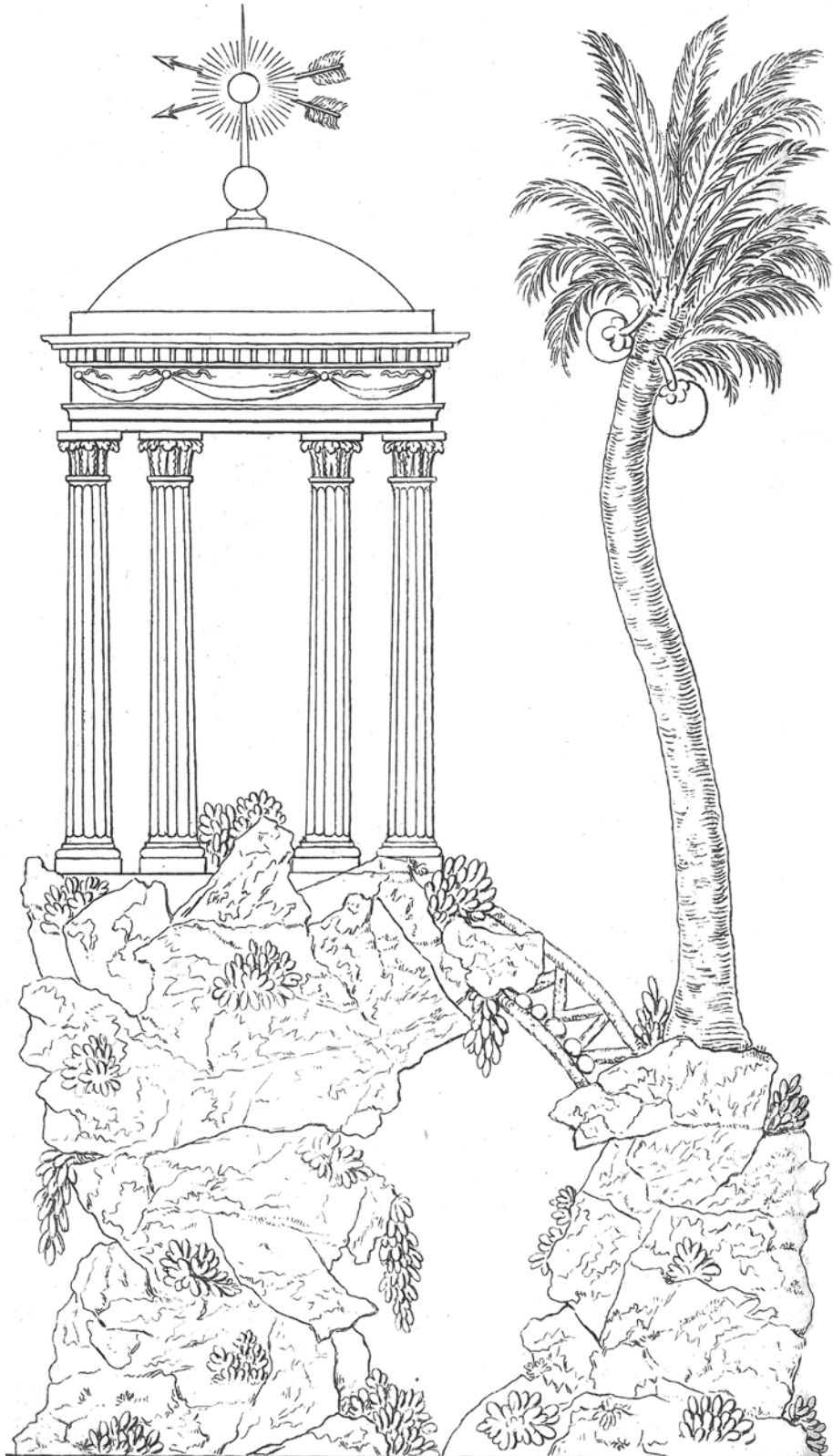

Carême, M.A. *Le Pâtissier royal parisien, ou Traité élémentaire et pratique de la pâtisserie ancienne et moderne.* (Paris, 1815) 07 GW-119, 07 GW-120. From: **Rare Book and Manuscript CRAI Library at University of Barcelona.**

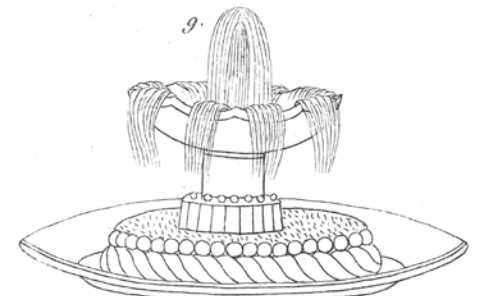
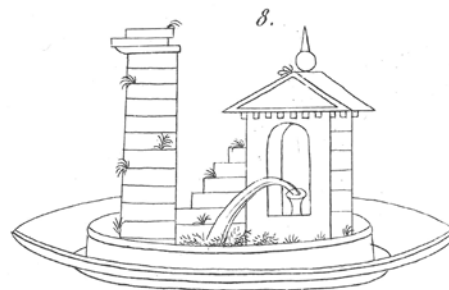
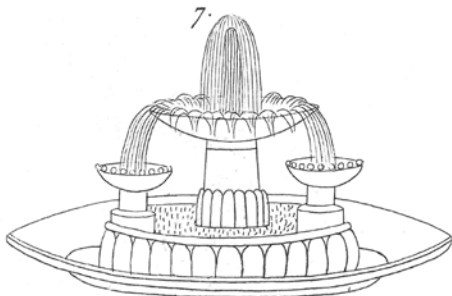
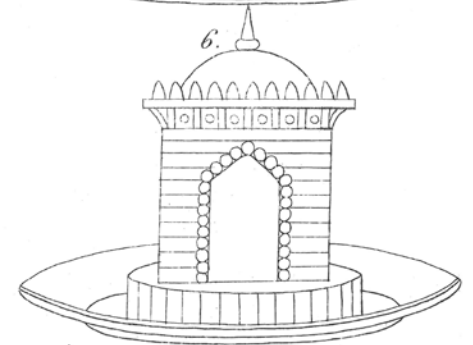
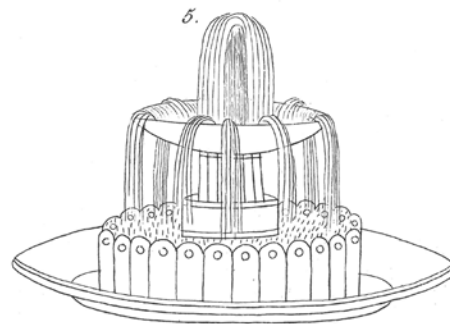
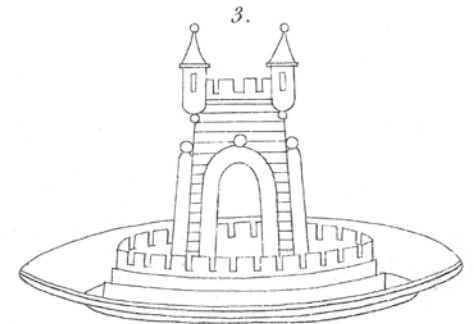
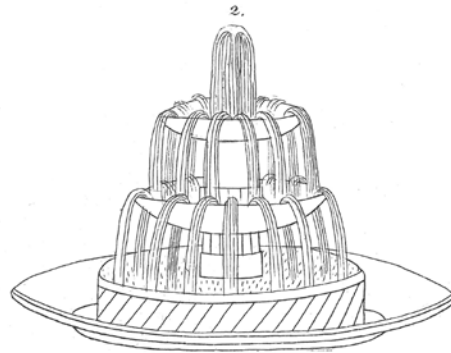
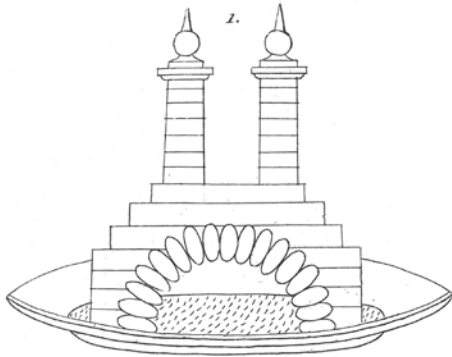

Carême, M.A. *Le Pâtissier royal parisien, ou Traité élémentaire et pratique de la pâtisserie ancienne et moderne.* (Paris, 1815) 07 GW-119, 07 GW-120. From: **Rare Book and Manuscript CRAI Library at University of Barcelona.**

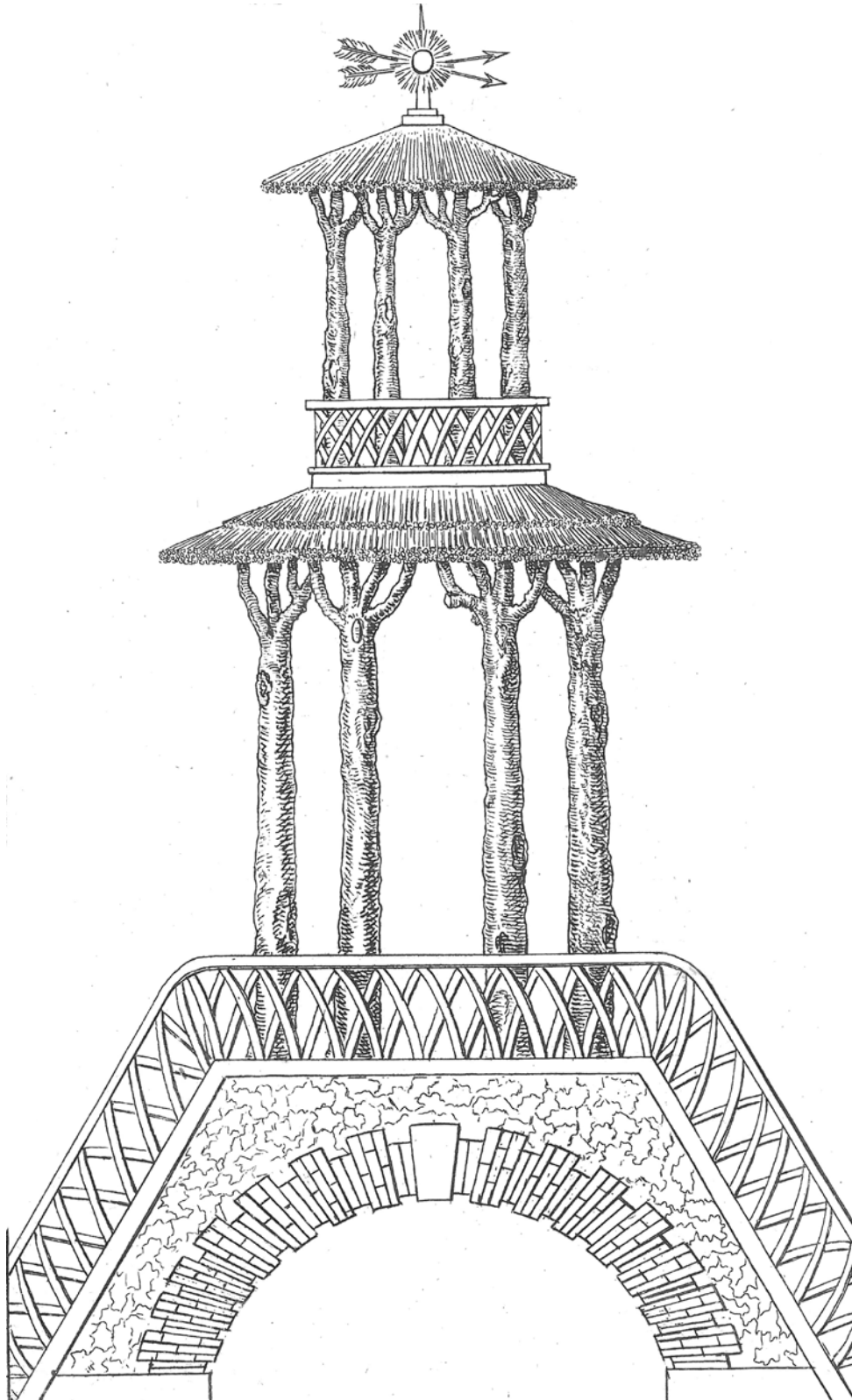

Carême, M.A. *Le Pâtissier royal parisien, ou Traité élémentaire et pratique de la pâtisserie ancienne et moderne.* (Paris, 1815) 07 GW-119, 07 GW-120. From: **Rare Book and Manuscript CRAI Library at University of Barcelona.**

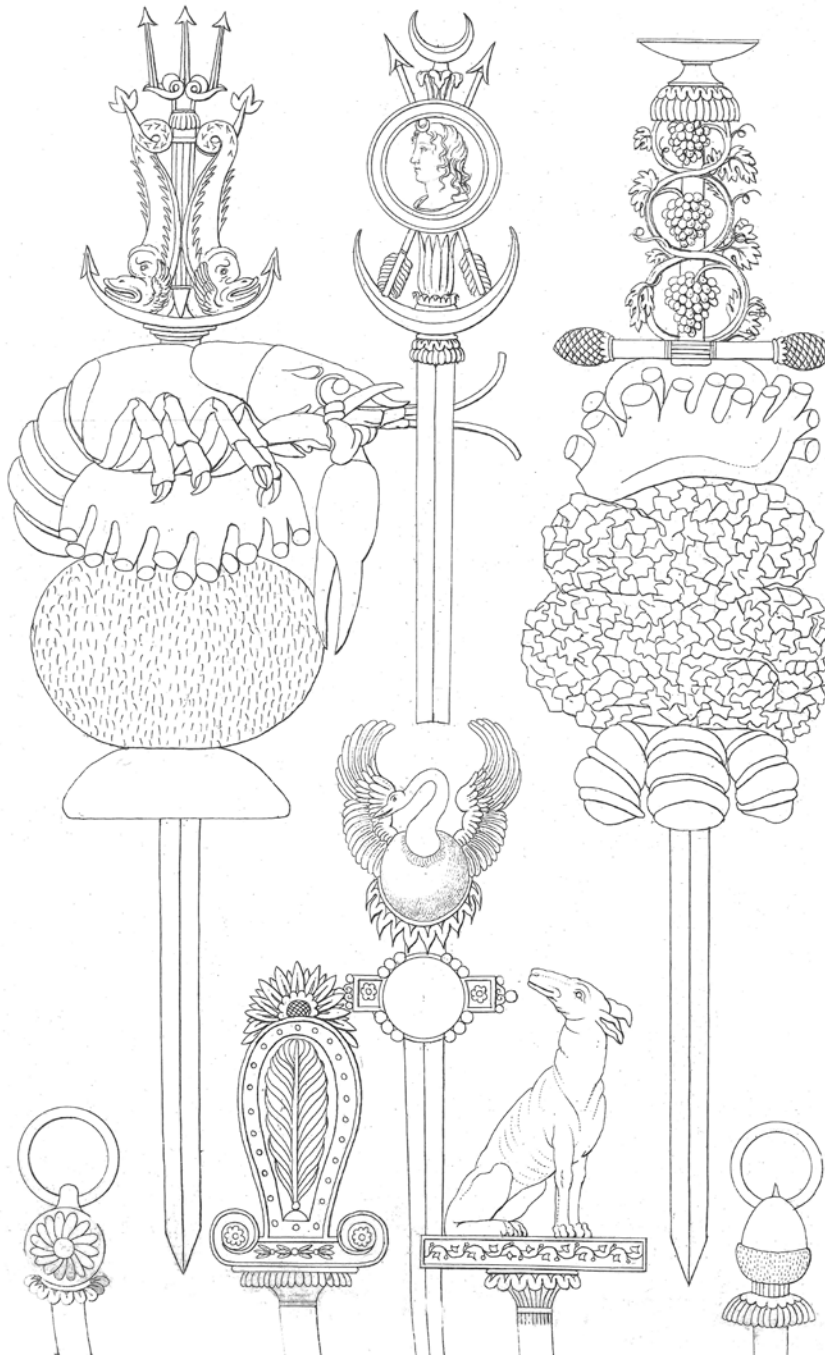

Carême, M.A. *Le Pâtissier royal parisien, ou Traité élémentaire et pratique de la pâtisserie ancienne et moderne.* (Paris, 1815) 07 GW-119, 07 GW-120. From: **Rare Book and Manuscript CRAI Library at University of Barcelona.**

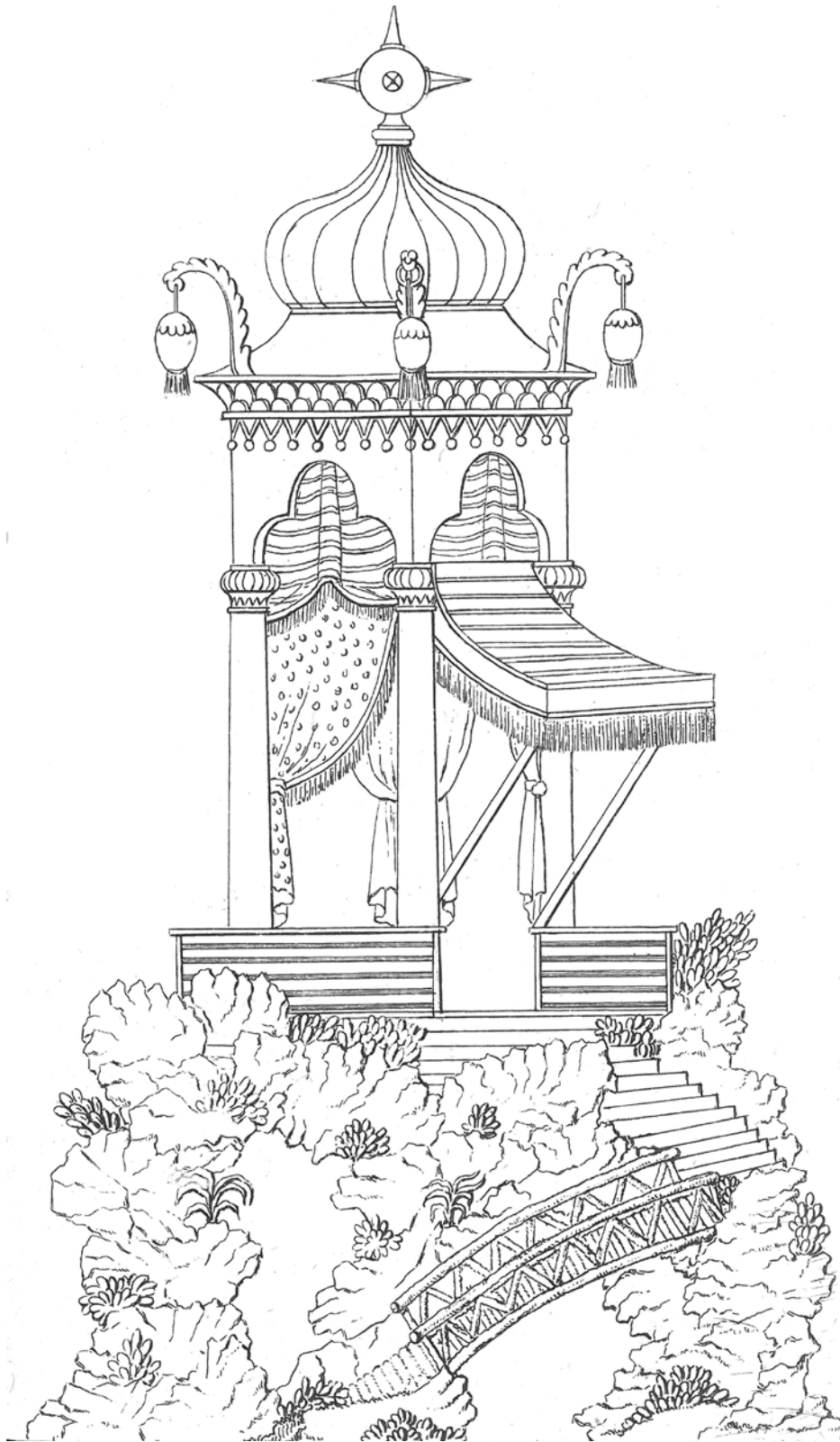

Carême, M.A. *Le Pâtissier royal parisien, ou Traité élémentaire et pratique de la pâtisserie ancienne et moderne.* (Paris, 1815) 07 GW-119, 07 GW-120. From: **Rare Book and Manuscript CRAI Library at University of Barcelona.**

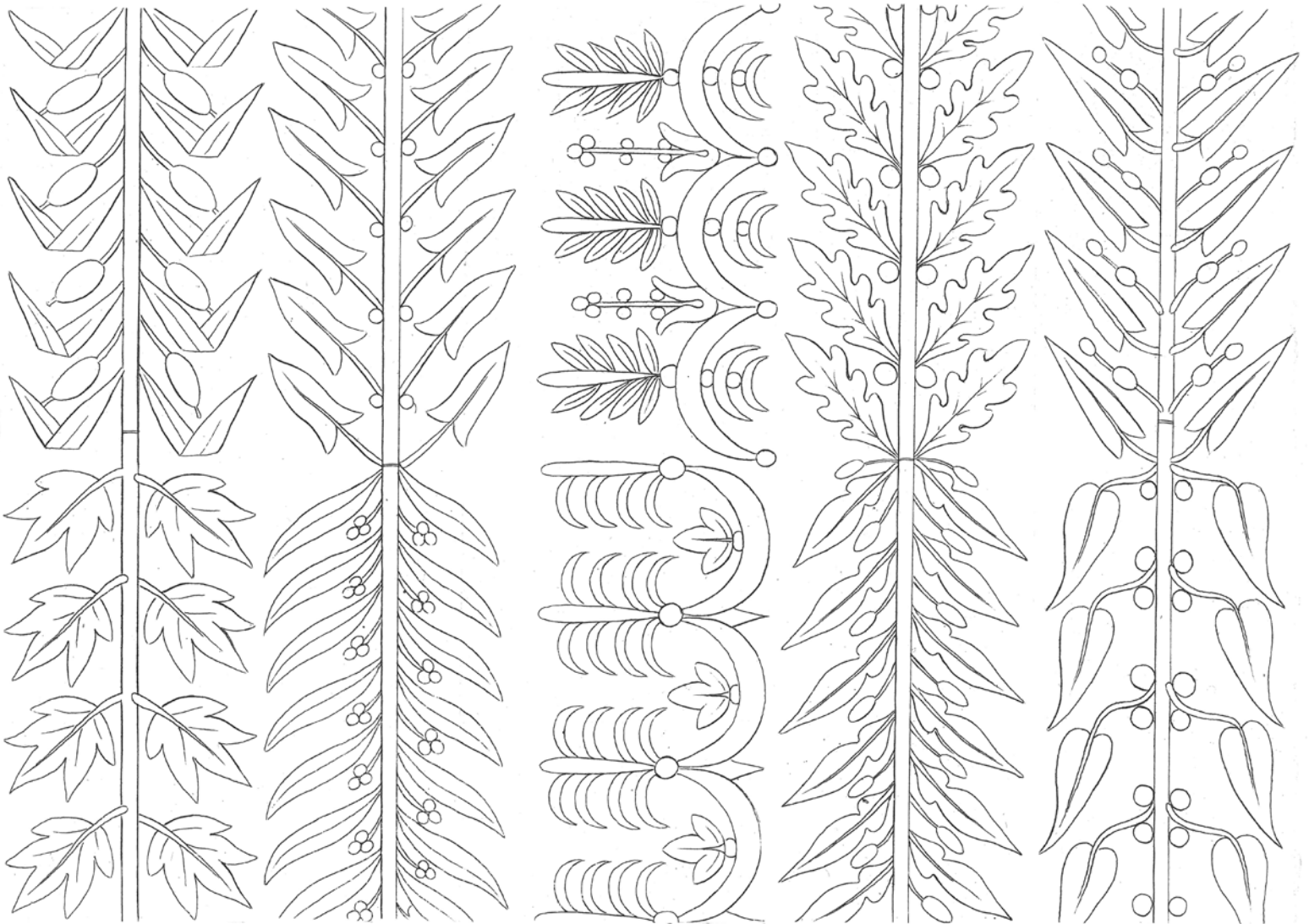

Carême, M.A. *Le Pâtissier royal parisien, ou Traité élémentaire et pratique de la pâtisserie ancienne et moderne.* (Paris, 1815) 07 GW-119, 07 GW-120. From: **Rare Book and Manuscript CRAI Library at University of Barcelona.**